

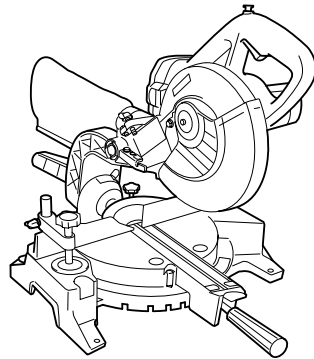

# Cordless Slide Compound Saw

Equipped with Electric Blade Brake  
190 mm (7-1/2")  
MODEL LS711D



002214

## I N S T R U C T I O N M A N U A L

**⚠ WARNING:**

For your personal safety, READ and UNDERSTAND before using.  
SAVE THESE INSTRUCTIONS FOR FUTURE REFERENCE.

# SPECIFICATIONS

**Blade diameter** ..... 190 mm (7-1/2")

**Hole (arbor) diameter** ..... 15.88 mm (5/8")

**Max. Miter angle** ..... Left 47°, Right 57°

**Max. Bevel angle** ..... Left 45°

**Max. Cutting capacities (H x W) with blade 190 mm (7-1/2") in diameter.**

Miter angle	Bevel angle	
	0°	45° (left)
0°	50 mm x 182 mm (2" x 7-1/8")	35 mm x 182 mm (1-3/8" x 7-1/8")
45° (left and right)	50 mm x 127 mm (2" x 5")	35 mm x 127 mm (1-3/8" x 5")

**(Note)**

**The max. Cutting capacities may vary according to workpiece, blade and/or charging condition.**

**No load speed (RPM)** ..... 2,000/min.

**Dimensions (L x W x H)** ..... 550 mm x 430 mm x 454 mm (21-5/8" x 17" x 17-7/8")

**Net weight** ..... 10.5 kg (23.1 lbs)

Battery Charger	DC1804			
Input	A.C. only 50 Hz-60 Hz			
Output	D.C. 7.2 V-18 V			
Battery Cartridge	1822	1833	1834	1835
Voltage	18 V			
Charging time	45 min.	50 min.	60 min.	70 min.

- Manufacturer reserves the right to change specifications without notice.
- Specifications may differ from country to country.

---

# For Your Own Safety Read Instruction Manual Before Operating Tool

## Save it for future reference

### GENERAL SAFETY PRECAUTIONS

USA005-1

#### (For All TOOLS)

1. **KNOW YOUR POWER TOOL.** Read the owner's manual carefully. Learn the tool's applications and limitations, as well as the specific potential hazards peculiar to it.
2. **KEEP GUARDS IN PLACE** and in working order.
3. **REMOVE ADJUSTING KEYS AND WRENCHES.** Form habit of checking to see that keys and adjusting wrenches are removed from tool before turning it on.
4. **KEEP WORK AREA CLEAN.** Cluttered areas and benches invite accidents.
5. **DON'T USE IN DANGEROUS ENVIRONMENT.** Don't use power tools in damp or wet locations, or expose them to rain. Keep work area well lighted. Don't use tool in presence of flammable liquids or gases.
6. **KEEP CHILDREN AWAY.** All visitors should be kept safe distance from work area.
7. **MAKE WORKSHOP KID PROOF** with padlocks, master switches, or by removing starter keys.
8. **DON'T FORCE TOOL.** It will do the job better and safer at the rate for which it was designed.
9. **USE RIGHT TOOL.** Don't force tool or attachment to do a job for which it was not designed.
10. **WEAR PROPER APPAREL.** Do not wear loose clothing, gloves, neckties, rings, bracelets, or other jewelry which may get caught in moving parts. Nonslip footwear is recommended. Wear protective hair covering to contain long hair.
11. **ALWAYS USE SAFETY GLASSES.** Also use face or dust mask if cutting operation is dusty. Everyday eyeglasses only have impact resistant lenses, they are NOT safety glasses.
12. **SECURE WORK.** Use clamps or a vise to hold work when practical. It's safer than using your hand and it frees both hands to operate tool.
13. **DON'T OVERREACH.** Keep proper footing and balance at all times.
14. **MAINTAIN TOOLS WITH CARE.** Keep tools sharp and clean for best and safest performance. Follow instructions for lubricating and changing accessories.
15. **DISCONNECT BATTERY FROM TOOL** before servicing; when changing accessories such as blades, bits, cutters, and the like.
16. **REDUCE THE RISK OF UNINTENTIONAL STARTING.** Make sure switch is in off position before inserting battery.
17. **USE RECOMMENDED ACCESSORIES.** Consult the owner's manual for recommended accessories. The use of improper accessories may cause risk of injury to persons.

- 
18. **NEVER STAND ON TOOL.** Serious injury could occur if the tool is tipped or if the cutting tool is unintentionally contacted.
  19. **CHECK DAMAGED PARTS.** Before further use of the tool, a guard or other part that is damaged should be carefully checked to determine that it will operate properly and perform its intended function - check for alignment of moving parts, binding of moving parts, breakage of parts, mounting, and any other conditions that may affect its operation. A guard or other part that is damaged should be properly repaired or replaced.
  20. **DIRECTION OF FEED.** Feed work into a blade or cutter against the direction of rotation of the blade or cutter only.
  21. **NEVER LEAVE TOOL RUNNING UNATTENDED. TURN POWER OFF.** Don't leave tool until it comes to a complete stop.

---

## **ADDITIONAL SAFETY RULES**

USB033-2

**DO NOT let comfort or familiarity with product (gained from repeated use) replace strict adherence to slide compound saw safety rules. If you use this tool unsafely or incorrectly, you can suffer serious personal injury.**

1. Wear eye protection.
2. Keep hands out of path of saw blade. Avoid contact with any coasting blade. It can still cause severe injury.
3. Do not operate saw without guards in place. Check blade guard for proper closing before each use. Do not operate saw if blade guard does not move freely and close instantly. Never clamp or tie the blade guard into the open position.
4. Do not perform any operation freehand. The workpiece must be secured firmly against the turn base and guide fence with a vise during all operations. Never use your hand to secure the workpiece.
5. Never reach around saw blade.
6. Turn off tool and wait for saw blade to stop before moving workpiece or changing settings.
7. Remove battery from tool before changing blade or servicing.
8. To reduce the risk of injury, return carriage to the full rear position after each crosscut operation.
9. Always secure all moving portions before carrying the tool.
10. Stopper pin which locks the cutter head down is for carrying and storage purposes only and not for any cutting operations.
11. Be aware that this tool is always in an operating condition, because it does not have to be plugged into an electrical outlet.
12. Do not use the tool in the presence of flammable liquids or gases.
13. Check the blade carefully for cracks or damage before operation. Replace cracked or damaged blade immediately. Gum and wood pitch hardened on blades slows saw and increases potential for kickback. Keep blade clean by first remov-

- ing it from tool, then cleaning it with gum and pitch remover, hot water or kerosene. Never use gasoline to clean blade.
14. While making a slide cut, KICKBACK can occur. KICKBACK occurs when the blade binds in the workpiece during a cutting operation and the saw blade is driven back rapidly towards the operator. Loss of control and serious personal injury can result. If blade begins to bind during a cutting operation, do not continue to cut and release switch immediately.
  15. Use only flanges specified for this tool.
  16. Be careful not to damage the arbor, flanges (especially the installing surface) or bolt. Damage to these parts could result in blade breakage.
  17. Make sure that the turn base is properly secured so it will not move during operation. Use the holes in the base to fasten the saw to a stable work platform or bench. NEVER use tool where operator positioning would be awkward.
  18. For your safety, remove the chips, small pieces, etc. from the table top before operation.
  19. Avoid cutting nails. Inspect for and remove all nails from the workpiece before operation.
  20. Make sure the shaft lock is released before the switch is turned on.
  21. Be sure that the blade does not contact the turn base in the lowest position.
  22. Hold the handle firmly. Be aware that the saw moves up or down slightly during start-up and stopping.
  23. Make sure the blade is not contacting the workpiece before the switch is turned on.
  24. Before using the tool on an actual workpiece, let it run for a while. Watch for vibration or wobbling that could indicate poor installation or a poorly balanced blade.
  25. Wait until the blade attains full speed before cutting.
  26. Stop operation immediately if you notice anything abnormal.
  27. Do not attempt to lock the trigger in the on position.
  28. Be alert at all times, especially during repetitive, monotonous operations. Do not be lulled into a false sense of security. Blades are extremely unforgiving.
  29. Always use accessories recommended in this manual. Use of improper accessories such as abrasive wheels may cause an injury.
  30. NEVER hold workpiece on right side of blade with left hand or vice versa. This is called cross-armed cutting and exposes user to risk of **SERIOUS PERSONAL INJURY** as shown in the figure. ALWAYS use vise to secure workpiece.
- 
31. NEVER stack workpieces on the table top to speed cutting operations. Cut only one piece at a time.
  32. Some material contains chemicals which may be toxic. Take caution to prevent dust inhalation and skin contact. Follow material supplier safety data.

---

# SAVE THESE INSTRUCTIONS

**⚠ WARNING:**  
**MISUSE** or failure to follow the safety rules stated in this instruction manual may cause serious personal injury.

---

## IMPORTANT SAFETY INSTRUCTIONS FOR CHARGER & BATTERY CARTRIDGE

USC001-3

1. **SAVE THESE INSTRUCTIONS** - This manual contains important safety and operating instructions for battery charger.
2. Before using battery charger, read all instructions and cautionary markings on (1) battery charger, (2) battery, and (3) product using battery.
3. **CAUTION** - To reduce risk of injury, charge only **MAKITA** rechargeable batteries marked on the charger label. Other types of batteries may burst causing personal injury and damage.
4. Do not expose charger to rain or snow.
5. Use of an attachment not recommended or sold by the battery charger manufacturer may result in a risk of fire, electric shock, or injury to persons.
6. To reduce risk of damage to electric plug and cord, pull by plug rather than cord when disconnecting charger.
7. Make sure cord is located so that it will not be stepped on, tripped over, or otherwise subjected to damage or stress.
8. An extension cord should not be used unless absolutely necessary. Use of improper extension cord could result in a risk of fire and electric shock. If extension cord must be used, make sure:
  - a. That pins on plug of extension cord are the same number, size, and shape as those of plug on charger;
  - b. That extension cord is properly wired and in good electrical condition;
  - c. That wire size is at least as large as the one specified in the table below.

Table 1: RECOMMENDED MINIMUM AWG SIZE FOR EXTENSION CORDS FOR BATTERY CHARGERS

Length of Cord (Feet)	25	50	100	150
AWG Size of Cord	18	18	18	16

9. Do not operate charger with damaged cord or plug - replace them immediately.
10. Do not operate charger if it has received a sharp blow, been dropped, or otherwise damaged in any way; take it to a qualified serviceman.
11. Do not disassemble charger or battery cartridge; take it to a qualified serviceman when service or repair is required, Incorrect reassembly may result in a risk of electric shock or fire.

- 
12. To reduce risk of electric shock, unplug charger from outlet before attempting any maintenance or cleaning. Turning off controls will not reduce this risk.
  13. The battery charger is not intended for use by young children or infirm persons without supervision.
  14. Young children should be supervised to ensure that they do not play with the battery charger.
  15. If operating time has become excessively shorter, stop operating immediately. It may result in a risk of overheating, possible burns and even an explosion.
  16. If electrolyte gets into your eyes, rinse them out with clear water and seek medical attention right away. It may result in loss of your eyesight.

---

## ADDITIONAL SAFETY RULES FOR CHARGER & BATTERY CARTRIDGE

1. Do not charge Battery Cartridge when temperature is BELOW 10°C (50°F) or ABOVE 40°C (104°F).
2. Do not attempt to use a step-up transformer, an engine generator or DC power receptacle.
3. Do not allow anything to cover or clog the charger vents.
4. Always cover the battery terminals with the battery cover when the battery cartridge is not used.
5. Do not short the battery cartridge:
  - (1) Do not touch the terminals with any conductive material.
  - (2) Avoid storing battery cartridge in a container with other metal objects such as nails, coins, etc.
  - (3) Do not expose battery cartridge to water or rain.

A battery short can cause a large current flow, overheating, possible burns and even a breakdown.
6. Do not store the tool and Battery Cartridge in locations where the temperature may reach or exceed 50°C (122°F).
7. Do not incinerate the Battery Cartridge even if it is severely damaged or is completely worn out. The battery cartridge can explode in a fire.
8. Be careful not to drop, shake or strike battery.
9. Do not charge inside a box or container of any kind. The battery must be placed in a well ventilated area during charging.

---

## SAVE THESE INSTRUCTIONS

## INSTALLATION

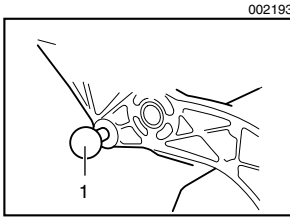

1. Stopper Pin

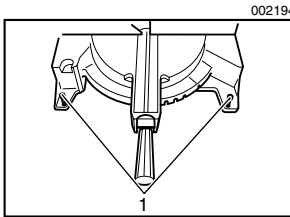

1. Bolt

### Bench mounting

When the tool is shipped, the handle is locked in the lowered position by the stopper pin. Release the stopper pin by lowering the handle slightly and pulling the stopper pin.

This tool should be bolted with two bolts to a level and stable surface using the bolt holes provided in the tool's base. This will help prevent tipping and possible injury.

## FUNCTIONAL DESCRIPTION

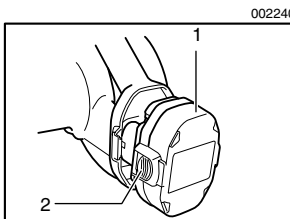

1. Battery cartridge  
2. Button

### ⚠ CAUTION:

- Always be sure that the tool is switched off and the battery cartridge is removed before adjusting or checking function on the tool.

### Installing or removing battery cartridge

- Always switch off the tool before insertion or removal of the battery cartridge.
- To remove the battery cartridge, withdraw it from the tool while pressing the buttons on both sides of the cartridge.
- To insert the battery cartridge, align the tongue on the battery cartridge with the groove in the housing and slip it into place. Always insert it all the way until it locks in place with a little click. If not, it may accidentally fall out of the tool, causing injury to you or someone around you.
- Do not use force when inserting the battery cartridge. If the cartridge does not slide in easily, it is not being inserted correctly.



004513

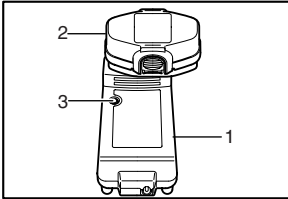

1. Battery charger
2. Battery cartridge
3. Charging light

## Charging

1. Plug the battery charger into the proper AC voltage source. The charging light will flash in green color.
2. Insert the battery cartridge so that the plus and minus terminals on the battery cartridge are on the same sides as their respective markings on the charger. Insert the cartridge fully into the port so that it rests on the charger port floor.
3. When the battery cartridge is inserted, the charging light color will change from green to red and charging will begin. The charging light will remain lit steadily during charging.
4. When the charging light color changes from red to green, the charging cycle is complete.
5. If you leave the battery cartridge in the charger after the charging cycle is complete, the charger will switch into its “trickle charge (maintenance charge)” mode.
6. After charging, unplug the charger from the power source.

### NOTE:

- The battery charger is for charging Makita battery cartridge. Never use it for other purposes or for other manufacturer's batteries.
- When you charge a new battery cartridge or a battery cartridge which has not been used for a long period of time, it may not accept a full charge. This is a normal condition and does not indicate a problem. You can recharge the battery cartridge fully after discharging it completely and recharging a couple of times.
- If you charge a battery cartridge from a just operated tool or a battery cartridge which has been left in a location exposed to direct sunlight or heat for a long time, the charging light may flash in red color. If this occurs, wait for a while. Charging will begin after the battery cartridge cools. The battery cartridge will cool faster if you remove the battery cartridge from the battery charger.
- If the charging light flashes alternately in green and red color, charging is not possible. The terminals on the charger or battery cartridge are clogged with dust or the battery cartridge is worn out or damaged.

### Trickle charge (Maintenance charge)

If you leave the battery cartridge in the charger to prevent spontaneous discharging after full charge, the charger will switch into its “trickle charge (maintenance charge)” mode and keep the battery cartridge fresh and fully charged.

### Tips for maintaining maximum battery life

1. Charge the battery cartridge before completely discharged.  
Always stop tool operation and charge the battery cartridge when you notice less tool power.
2. Never recharge a fully charged battery cartridge.  
Overcharging shortens the battery service life.
3. Charge the battery cartridge with room temperature at 10°C - 40°C (50°F - 104°F).  
Let a hot battery cartridge cool down before charging it.
4. Charge the Nickel Metal Hydride battery cartridge when you do not use it for more than six months.

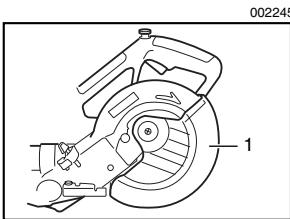

1. Blade guard

### Blade guard

When lowering the handle, the blade guard rises automatically. The guard is spring loaded so it returns to its original position when the cut is completed and the handle is raised. NEVER DEFEAT OR REMOVE THE BLADE GUARD OR THE SPRING WHICH ATTACHES TO THE GUARD.

In the interest of your personal safety, always maintain the blade guard in good condition. Any irregular operation of the blade guard should be corrected immediately. Check to assure spring loaded return action of guard. NEVER USE THE TOOL IF THE BLADE GUARD OR SPRING ARE DAMAGED, FAULTY OR REMOVED. DOING SO IS HIGHLY DANGEROUS AND CAN CAUSE SERIOUS PERSONAL INJURY.

If the see-through blade guard becomes dirty, or sawdust adheres to it in such a way that the blade is no longer easily visible, remove the battery cartridge and clean the guard carefully with a damp cloth. Do not use solvents or any petroleum-based cleaners on the plastic guard.

001782

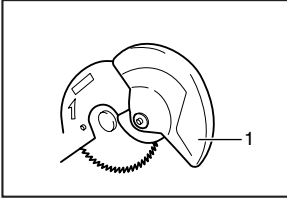

1. Blade guard

If the blade guard is especially dirty and vision through the guard is impaired, use the supplied socket wrench to loosen the hex bolt holding the center cover. Loosen the hex bolt by turning it counterclockwise and raise the blade guard and center cover. With the blade guard so positioned, cleaning can be more completely and efficiently accomplished. When cleaning is complete, reverse procedure above and secure bolt. Do not remove spring holding blade guard. If guard becomes discolored through age or UV light exposure, contact a Makita service center for a new guard. **DO NOT DEFEAT OR REMOVE GUARD.**

002195

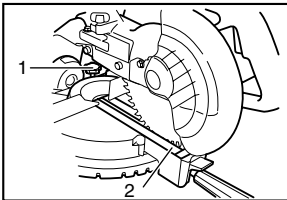

1. Clamp screw  
2. Kerf board

### Positioning kerf board

This tool is provided with the kerf boards in the turn base to minimize tearing on the exit side of a cut. The kerf boards are factory adjusted so that the saw blade does not contact the kerf boards. Before use, adjust the kerf boards as follows:

First, remove the battery cartridge. Loosen all the screws (2 each on left and right) securing the kerf boards. Re-tighten them only to the extent that the kerf boards can still be easily moved by hand. Lower the handle fully and push in the stopper pin to lock the handle in the lowered position. Loosen the clamp screw which secures the slide poles. Pull the carriage toward you fully. Adjust the kerf boards so that the kerf boards just contact the sides of the blade teeth. Tighten the front screws (do not tighten firmly). Push the carriage toward the guide fence fully and adjust the kerf boards so that the kerf boards just contact the sides of blade teeth. Tighten the rear screws (do not tighten firmly).

After adjusting the kerf boards, release the stopper pin and raise the handle. Then tighten all the screws securely.

001800

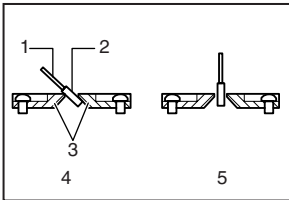

1. Saw blade  
2. Blade teeth  
3. Kerf board  
4. Left bevel cut  
5. Straight cut

### ⚠ CAUTION:

- Before and after changing the bevel angle, always adjust the kerf boards as described above.

002196

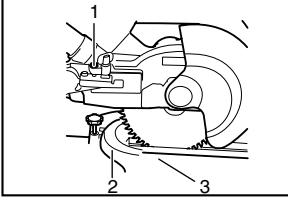

1. Adjusting bolt
2. Guide fence
3. Turn Base

## Maintaining maximum cutting capacity

This tool is factory adjusted to provide the maximum cutting capacity for a 190 mm (7-1/2") saw blade.

When installing a new blade, always check the lower limit position of the blade and if necessary, adjust it as follows:

First, remove the battery cartridge. Push the carriage toward the guide fence fully and lower the handle completely. Use the socket wrench to turn the adjusting bolt until the periphery of the blade extends slightly below the top surface of the turn base at the point where the front face of the guide fence meets the top surface of the turn base.

With the battery cartridge removed, rotate the blade by hand while holding the handle all the way down to be sure that the blade does not contact any part of the lower base. Re-adjust slightly, if necessary.

001540

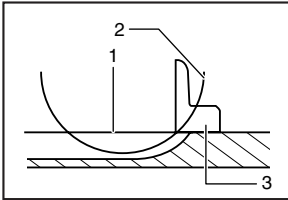

1. Top surface of turn base
2. Periphery of blade
3. Guide fence

### ⚠ CAUTION:

- After installing a new blade, always be sure that the blade does not contact any part of the lower base when the handle is lowered completely. Always do this with the battery cartridge removed.

002241

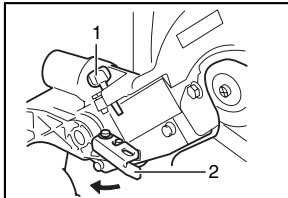

1. Adjusting screw
2. Stopper arm

## Stopper arm

The lower limit position of the blade can be easily adjusted with the stopper arm. To adjust it, move the stopper arm in the direction of the arrow as shown in the figure. Adjust the adjusting screw so that the blade stops at the desired position when lowering the handle fully.

002197

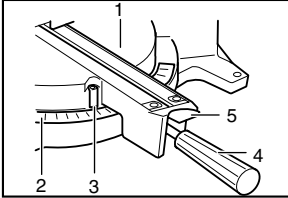

1. Turn base
2. Miter scale
3. Pointer
4. Grip
5. Lock lever

## Adjusting the miter angle

Loosen the grip by turning counterclockwise. Turn the turn base while pressing down the lock lever. When you have moved the grip to the position where the pointer points to the desired angle on the miter scale, securely tighten the grip clockwise.

### ⚠ CAUTION:

- When turning the turn base, be sure to raise the handle fully.
- After changing the miter angle, always secure the turn base by tightening the grip firmly.

002198

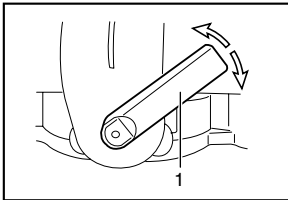

1. Lever

## Adjusting the bevel angle

To adjust the bevel angle, loosen the lever at the rear of the tool counterclockwise.

Push the handle to the left to tilt the saw blade until the pointer points to the desired angle on the bevel scale. Then tighten the lever clockwise firmly to secure the arm.

### ⚠ CAUTION:

- When tilting the saw blade, be sure to raise the handle fully.
- After changing the bevel angle, always secure the arm by tightening the lever clockwise.
- When changing bevel angles, be sure to position the kerf boards appropriately as explained in the “Positioning kerf boards” section.

002199

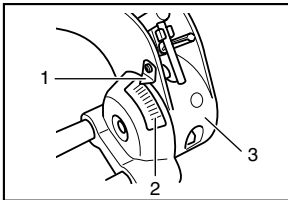

1. Pointer
2. Bevel scale
3. Arm

## Switch action

001811

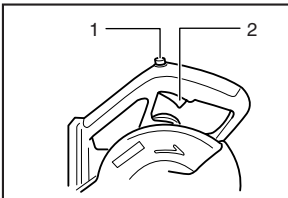

1. Lock-off button
2. Switch trigger

### ⚠ CAUTION:

- Before inserting the battery cartridge into the tool, always check to see that the switch trigger actuates properly and returns to the “OFF” position when released.
- When not using the tool, remove the lock-off button and store it in a secure place. This prevents unauthorized operation.

- 
- Do not pull the switch trigger hard without pressing in the lock-off button. This can cause switch breakage.

To prevent the switch trigger from being accidentally pulled, a lock-off button is provided. To start the tool, press in the lock-off button and pull the switch trigger. Release the switch trigger to stop.

**⚠ WARNING:**

- NEVER use tool without a fully operative switch trigger. Any tool with an inoperative switch is HIGHLY DANGEROUS and must be repaired before further usage.
- For your safety, this tool is equipped with a lock-off button which prevents the tool from unintended starting. NEVER use the tool if it runs when you simply pull the switch trigger without pressing the lock-off button. Return tool to a Makita service center for proper repairs BEFORE further usage.
- NEVER tape down or defeat purpose and function of lock-off button.

**Electric brake**

This tool is equipped with an electric blade brake. If the tool consistently fails to quickly stop blade after switch trigger release, have tool serviced at a Makita service center.

The blade brake system is not a substitute for blade guard. NEVER USE TOOL WITHOUT A FUNCTIONING BLADE GUARD. SERIOUS PERSONAL INJURY CAN RESULT.

**ASSEMBLY**

**⚠ CAUTION:**

- Always be sure that the tool is switched off and the battery cartridge is removed before carrying out any work on the tool.

002200

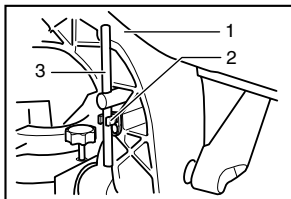

1. Arm
2. Wrench holder
3. Socket wrench

## Socket wrench storage

The socket wrench is stored as shown in the figure. When using the socket wrench, pull it out of the wrench holder. After using the socket wrench, return it to the wrench holder.

## Installing or removing saw blade

### ⚠ CAUTION:

- Always be sure that the tool is switched off and the battery cartridge is removed before installing or removing the blade.
- Use only the Makita socket wrench provided to install or remove the blade. Failure to do so may result in overtightening or insufficient tightening of the hex bolt. This could cause an injury.

002193

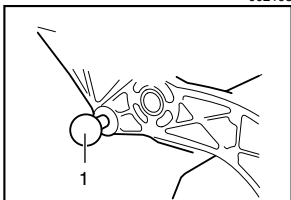

1. Stopper Pin

Lock the handle in the raised position by pushing in the stopper pin.

002215

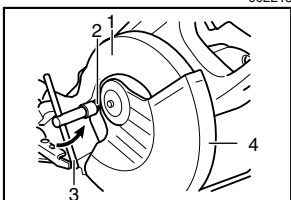

1. Blade Case
2. Hex bolt
3. Socket wrench
4. Blade guard

To remove the blade, use the socket wrench to loosen the hex bolt holding the center cover by turning it counterclockwise. Raise the blade guard and center cover.

002216

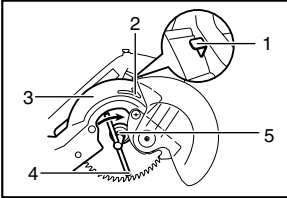

1. Shaft lock
2. Arrow
3. Blade case
4. Socket wrench
5. Hex bolt

Press the shaft lock to lock the spindle and use the socket wrench to loosen the hex bolt clockwise. Then remove the hex bolt, outer flange and blade.

001771

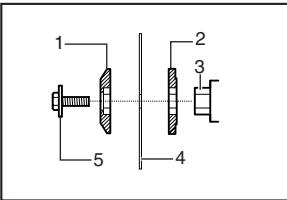

1. Outer flange
2. Inner flange
3. Spindle
4. Saw blade
5. Hex bolt

To install the blade, mount it carefully onto the spindle, making sure that the direction of the arrow on the surface of the blade matches the direction of the arrow on the blade case. Install the outer flange and hex bolt, and then use the socket wrench to tighten the hex bolt (left-handed) securely counter-clockwise while pressing the shaft lock.

Return the blade guard and center cover to its original position. Then tighten the hex bolt clockwise to secure the center cover. Release the handle from the raised position by pulling the stopper pin. Lower the handle to make sure that the blade guard moves properly. Make sure shaft lock has released spindle before making cut.

001783

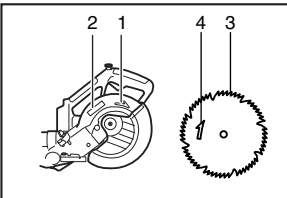

1. Arrow
2. Blade case
3. Saw blade
4. Arrow



002217

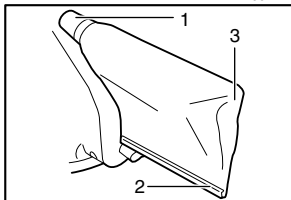

1. Dust nozzle
2. Fastener
3. Dust bag

## Dust bag

The use of the dust bag makes cutting operations clean and dust collection easy. To attach the dust bag, fit it onto the dust nozzle.

When the dust bag is about half full, remove the dust bag from the tool and pull the fastener out. Empty the dust bag of its contents, tapping it lightly so as to remove particles adhering to the insides which might hamper further collection.

### NOTE:

If you connect a Makita vacuum cleaner to your saw, more efficient and cleaner operations can be performed.

## Securing workpiece

### ⚠ WARNING:

- It is extremely important to always secure the workpiece properly and tightly with the vise. Failure to do so can cause the tool to be damaged and/or the workpiece to be destroyed. **PERSONAL INJURY MAY ALSO RESULT.** Also, after a cutting operation, **DO NOT** raise the blade until the blade has come to a complete stop.

001549

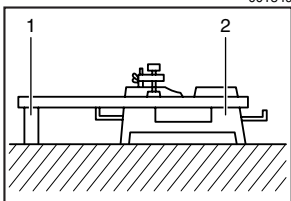

1. Support
2. Turn base

### ⚠ CAUTION:

- When cutting long workpieces, use supports that are as high as the top surface level of the turn base. Do not rely solely on the vertical vise and/or horizontal vise to secure the workpiece. Thin material tends to sag. Support workpiece over its entire length to avoid blade pinch and possible **KICKBACK.**

001806

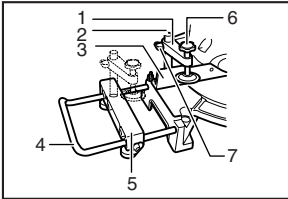

1. Vise arm
2. Vise rod
3. Guide fence
4. Holder
5. Holder assembly
6. Vise knob
7. Screw

## Vertical vise

The vertical vise can be installed in two positions on either the left or right side of the guide fence or the holder assembly (optional accessory). Insert the vise rod into the hole in the guide fence or the holder assembly and tighten the screw to secure the vise rod.

Position the vise arm according to the thickness and shape of the workpiece and secure the vise arm by tightening the screw. If the screw to secure the vise arm contacts the guide fence, install the screw on the opposite side of vise arm. Make sure that no part of the tool contacts the vise when lowering the handle fully and pulling or pushing the carriage all the way. If some part contacts the vise, re-position the vise.

Press the workpiece flat against the guide fence and the turn base. Position the workpiece at the desired cutting position and secure it firmly by tightening the vise knob.

### ⚠ CAUTION:

- The workpiece must be secured firmly against the turn base and guide fence with the vise during all operations.

001807

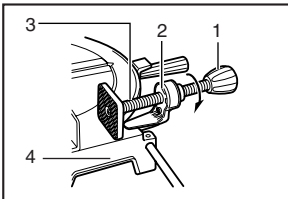

1. Vise knob
2. Projection
3. Vise shaft
4. Base

## Horizontal vise (optional accessory)

The horizontal vise can be installed on the left side of the base. By turning the vise knob counterclockwise, the screw is released and the vise shaft can be moved rapidly in and out. By turning the vise knob clockwise, the screw remains secured. To grip the workpiece, turn the vise knob gently clockwise until the projection reaches its topmost position, then fasten securely. If the vise knob is forced in or pulled out while being turned clockwise, the projection may stop at an angle. In this case, turn the vise knob back counterclockwise until the screw is released, before turning again gently clockwise.

The maximum width of the workpiece which can be secured by the horizontal vise is 120 mm (4-3/4").

### ⚠ CAUTION:

- Grip the workpiece only when the projection is at the topmost position. Failure to do so may result in insufficient securing of the workpiece. This could cause the workpiece to be thrown, cause damage to the blade or cause the loss of control, which can result in PERSONAL INJURY.

002247

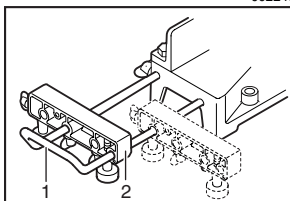

1. Holder
2. Holder assembly

## 002247 Holders and holder assembly (optional accessories)

The holders and the holder assembly can be installed on either side as a convenient means of supporting workpieces horizontally. Install them as shown in the figure. Then tighten the screws firmly to secure the holders and the holder assembly.

002246

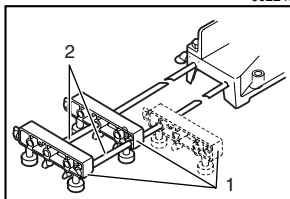

1. Holder assembly
2. Rod 12

When cutting long workpieces, use the holder-rod assembly (optional accessory). It consists of two holder assemblies and two rods 12.

### ⚠ CAUTION:

- Always support long workpieces level with the top surface of the turn base for accurate cuts and to prevent dangerous loss of control of the tool.

## OPERATION

### ⚠ CAUTION:

- Before use, be sure to release the handle from the lowered position by pulling the stopper pin.
- Make sure the blade is not contacting the workpiece, etc. before the switch is turned on.
- Do not apply excessive pressure on the handle when cutting. Too much force may result in overload of the motor and/or decreased cutting efficiency. Push down handle with only as much force as is necessary for smooth cutting and without significant decrease in blade speed.
- Gently press down the handle to perform the cut. If the handle is pressed down with force or if lateral force is applied, the blade will vibrate and leave a mark (saw mark) in the workpiece and the precision of the cut will be impaired.
- During a slide cut, gently push the carriage toward the guide fence without stopping. If the carriage movement is stopped during the cut, a mark will be left in the workpiece and the precision of the cut will be impaired.

002218

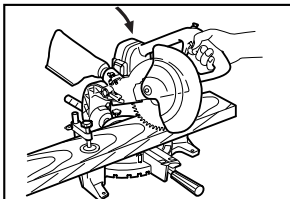

### 1. Press cutting (cutting small workpieces)

Workpieces up to 50 mm (2") high and 97 mm (3-13/16") wide can be cut in the following way.

Push the carriage toward the guide fence fully and tighten the clamp screw on the turn base clockwise to secure the carriage. Secure the workpiece with the vise. Switch on the tool without the blade making any contact and wait until the blade attains full speed before lowering. Then gently lower the handle to the fully lowered position to cut the workpiece. When the cut is completed, switch off the tool and **WAIT UNTIL THE BLADE HAS COME TO A COMPLETE STOP** before returning the blade to its fully elevated position.

#### ⚠ CAUTION:

- Firmly tighten the clamp screw on the turn base clockwise so that the carriage will not move during operation. Insufficient tightening may cause unexpected kickback of the blade. Possible serious **PERSONAL INJURY** may result.

002219

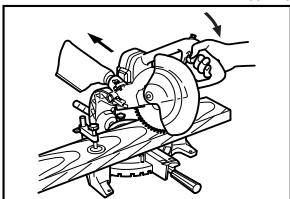

### 2. Slide (push) cutting (cutting wide workpieces)

Loosen the clamp screw on the turn base counterclockwise so that the carriage can slide freely. Secure the workpiece with the vise. Pull the carriage toward you fully. Switch on the tool without the blade making any contact and wait until the blade attains full speed. Press down the handle and **PUSH THE CARRIAGE TOWARD THE GUIDE FENCE AND THROUGH THE WORKPIECE**. When the cut is completed, switch off the tool and **WAIT UNTIL THE BLADE HAS COME TO A COMPLETE STOP** before returning the blade to its fully elevated position.

#### ⚠ CAUTION:

- Whenever performing the slide cut, **FIRST PULL THE CARRIAGE TOWARD YOU FULLY** and press down the handle to the fully lowered position, then **PUSH THE CARRIAGE TOWARD THE GUIDE FENCE**. **NEVER START THE CUT WITH THE CARRIAGE NOT FULLY PULLED TOWARD YOU**. If you perform the slide cut without pulling the carriage fully or if you perform the slide cut toward your direction, the blade may kickback unexpectedly with the potential to cause serious **PERSONAL INJURY**.

- Never perform the slide cut with the handle locked in the lowered position by pressing the stopper pin.
- Never loosen the clamp screw which secures the carriage while the blade is rotating. This may cause serious injury.

### 3. Miter cutting

Refer to the previously covered “Adjusting the miter angle”.

### 4. Bevel cut

Loosen the lever and tilt the saw blade to set the bevel angle (Refer to the previously covered “Adjusting the bevel angle”). Be sure to retighten the lever firmly to secure the selected bevel angle safely. Secure the workpiece with a vise. Make sure the carriage is pulled all the way back toward the operator. Switch on the tool without the blade making any contact and wait until the blade attains full speed. Then gently lower the handle to the fully lowered position while applying pressure in parallel with the blade and **PUSH THE CARRIAGE TOWARD THE GUIDE FENCE TO CUT THE WORKPIECE**. When the cut is completed, switch off the tool and **WAIT UNTIL THE BLADE HAS COME TO A COMPLETE STOP** before returning the blade to its fully elevated position.

#### **⚠ CAUTION:**

- Always be sure that the blade will move down to bevel direction during a bevel cut. Keep hands out of path of saw blade.
- During a bevel cut, it may create a condition whereby the piece cut off will come to rest against the side of the blade. If the blade is raised while the blade is still rotating, this piece may be caught by the blade, causing fragments to be scattered which is dangerous. The blade should be raised **ONLY** after the blade has come to a complete stop.
- When pressing the handle down, apply pressure parallel to the blade. If the pressure is not parallel to the blade during a cut, the angle of the blade might be shifted and the precision of the cut will be impaired.

### 5. Compound cutting

Compound cutting is the process in which a bevel angle is made at the same time in which a miter angle is being cut on a workpiece. Compound cutting can be performed at angle shown in the table.

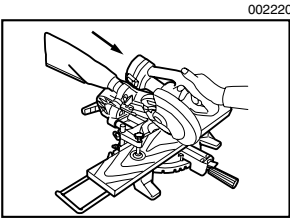

Miter angle	Bevel angle
Left and Right 45°	Left 0° - 45°
Right 50°	Left 0° - 40°
Right 55°	Left 0° - 30°
Right 60°	Left 0° - 25°

When performing compound cutting, refer to “Press cutting”, “Slide cutting”, “Miter cutting” and “Bevel cut” explanations.

## 6. Cutting crown and cove moldings

Crown and cove moldings can be cut on a compound miter saw with the moldings laid flat on the turn base.

There are two common types of crown moldings and one type of cove moldings; 52/38° wall angle crown molding, 45° wall angle crown molding and 45° wall angle cove molding. See illustrations.

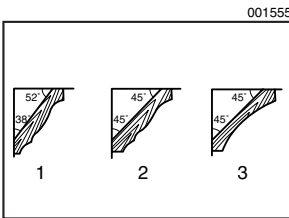

1. 52/38° type crown molding
2. 45° type crown molding
3. 45° type cove molding

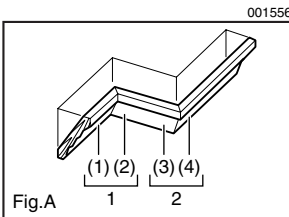

1. Inside corner
2. Outside corner

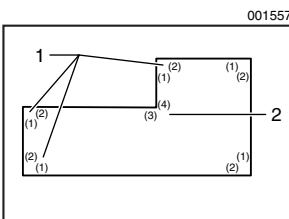

1. Inside corner
2. Outside corner

There are crown and cove molding joints which are made to fit “Inside” 90° corners ((1) and (2) in Fig. A) and “Outside” 90° corners ((3) and (4) in Fig. A).

### Measuring

Measure the wall length and adjust workpiece on table to cut wall contact edge to desired length. Always make sure that cut workpiece length **at the back of the workpiece** is the same as wall length. Adjust cut length for angle of cut. Always use several pieces for test cuts to check the saw angles.

When cutting crown and cove moldings, set the bevel angle and miter angle as indicated in the table (A) and position the moldings on the top surface of the saw base as indicated in the table (B).

Table (A)

	Molding position in Fig. A	Bevel angle		Miter angle	
		52/38° type	45° type	52/38° type	45° type
For inside corner	(1)	Left 33.9°	Left 30°	Right 31.6°	Right 35.3°
	(2)			Left 31.6°	Left 35.3°
For outside corner	(3)			Right 31.6°	Right 35.3°
	(4)			Right 31.6°	Right 35.3°

Table (B)

	Molding position in Fig. A	Molding edge against guide fence	Finished piece
For inside corner	(1)	Ceiling contact edge should be against guide fence.	Finished piece will be on the Left side of blade.
	(2)	Wall contact edge should be against guide fence.	
For outside corner	(3)	Wall contact edge should be against guide fence.	Finished piece will be on the Right side of blade.
	(4)	Ceiling contact edge should be against guide fence.	

**Example:**

In the case of cutting 52/38° type crown molding for position (1) in Fig. A:

- Tilt and secure bevel angle setting to 33.9° LEFT.
- Adjust and secure miter angle setting to 31.6° RIGHT.
- Lay crown molding with its broad back (hidden) surface down on the turn base with its CEILING CONTACT EDGE against the guide fence on the saw.
- The finished piece to be used will always be on the LEFT side of the blade after the cut has been made.

000031

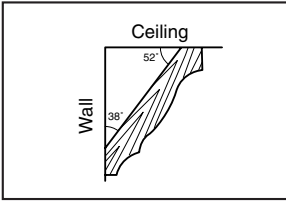

## Compound Miter Saw Miter and Bevel Angle Settings

### Wall to Crown Molding Angle: 52/38 degrees

Wall Angle (deg.)	Bevel Angle (deg.)	Miter Angle (deg.)
△ 60	43.0	46.8
61	42.8	46.3
62	42.5	45.7
63	42.2	45.1
64	41.9	44.6
65	41.7	44.0
66	41.4	43.5
67	41.1	42.9
68	40.8	42.4
69	40.5	41.9
70	40.2	41.3
71	39.9	40.8
72	39.6	40.3
73	39.3	39.8
74	39.0	39.2
75	38.7	38.7
76	38.4	38.2
77	38.1	37.7
78	37.8	37.2
79	37.4	36.8
80	37.1	36.3
81	36.8	35.8
82	36.5	35.3
83	36.2	34.8
84	35.8	34.4
85	35.5	33.9
86	35.2	33.4
87	34.9	33.0
88	34.5	32.5
89	34.2	32.1
∠ 90	33.9	31.6
91	33.5	31.2
92	33.2	30.7
93	32.8	30.3
94	32.5	29.9
95	32.2	29.4
96	31.8	29.0
97	31.5	28.6
98	31.1	28.2
99	30.8	27.7
100	30.4	27.3

Wall Angle (deg.)	Bevel Angle (deg.)	Miter Angle (deg.)
101	30.1	26.9
102	29.7	26.5
103	29.4	26.1
104	29.0	25.7
105	28.7	25.3
106	28.3	24.9
107	28.0	24.5
108	27.6	24.1
109	27.2	23.7
110	26.9	23.3
111	26.5	22.9
112	26.1	22.6
113	25.8	22.2
114	25.4	21.8
115	25.0	21.4
116	24.7	21.0
117	24.3	20.7
118	23.9	20.3
119	23.6	19.9
∠ 120	23.2	19.6
121	22.8	19.2
122	22.5	18.8
123	22.1	18.5
124	21.7	18.1
125	21.3	17.8
126	21.0	17.4
127	20.6	17.1
128	20.2	16.7
129	19.8	16.4
130	19.5	16.0
131	19.1	15.7
132	18.7	15.3
133	18.3	15.0
134	17.9	14.6
135	17.6	14.3
136	17.2	14.0
137	16.8	13.6
138	16.4	13.3
139	16.0	13.0
140	15.8	12.8

Wall Angle (deg.)	Bevel Angle (deg.)	Miter Angle (deg.)
141	15.3	12.3
142	14.9	12.0
143	14.5	11.6
144	14.1	11.3
145	13.7	11.0
146	13.3	10.7
147	12.9	10.3
148	12.5	10.0
149	12.2	9.7
∠ 150	11.8	9.4
151	11.4	9.0
152	11.0	8.7
153	10.8	8.4
154	10.2	8.1
155	9.8	7.8
156	9.4	7.5
157	9.0	7.1
158	8.6	6.8
159	8.3	6.5
160	7.9	6.2
161	7.5	5.9
162	7.1	5.6
163	6.7	5.3
164	6.3	4.9
165	5.9	4.6
166	5.5	4.3
167	5.1	4.0
168	4.7	3.7
169	4.3	3.4
170	3.9	3.1
171	3.5	2.8
172	3.2	2.5
173	2.8	2.2
174	2.4	1.8
175	2.0	1.5
176	1.6	1.2
177	1.2	0.9
178	0.8	0.6
179	0.4	0.3
∠ 180	0.0	0.0



000032

## Compound Miter Saw Miter and Bevel Angle Settings

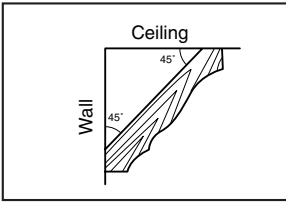

### Wall to Crown Molding Angle: 45 degrees

Wall Angle (deg.)	Bevel Angle (deg.)	Miter Angle (deg.)
△ 60	37.8	50.8
61	37.5	50.2
62	37.3	49.6
63	37.1	49.1
64	36.8	48.5
65	36.6	48.0
66	36.4	47.4
67	36.1	46.9
68	35.9	46.4
69	35.6	45.8
70	35.4	45.3
71	35.1	44.8
72	34.9	44.2
73	34.6	43.7
74	34.4	43.2
75	34.1	42.7
76	33.9	42.1
77	33.6	41.6
78	33.3	41.1
79	33.1	40.6
80	32.8	40.1
81	32.5	39.6
82	32.3	39.1
83	32.0	38.6
84	31.7	38.1
85	31.4	37.7
86	31.1	37.2
87	30.9	36.7
88	30.6	36.2
89	30.3	35.7
∠ 90	30.0	35.3
91	29.7	34.8
92	29.4	34.3
93	29.1	33.9
94	28.8	33.4
95	28.5	32.9
96	28.2	32.5
97	27.9	32.0
98	27.6	31.6
99	27.3	31.1
100	27.0	30.7

Wall Angle (deg.)	Bevel Angle (deg.)	Miter Angle (deg.)
101	26.7	30.2
102	26.4	29.8
103	26.1	29.4
104	25.8	28.9
105	25.5	28.5
106	25.2	28.1
107	24.9	27.6
108	24.6	27.2
109	24.2	26.8
110	23.9	26.3
111	23.6	25.9
112	23.3	25.5
113	23.0	25.1
114	22.7	24.7
115	22.3	24.3
116	22.0	23.8
117	21.7	23.4
118	21.4	23.0
119	21.0	22.6
∠ 120	20.7	22.2
121	20.4	21.8
122	20.0	21.4
123	19.7	21.0
124	19.4	20.6
125	19.1	20.2
126	18.7	19.8
127	18.4	19.4
128	18.1	19.0
129	17.7	18.6
130	17.4	18.2
131	17.1	17.9
132	16.7	17.5
133	16.4	17.1
134	16.0	16.7
135	15.7	16.3
136	15.4	15.9
137	15.0	15.6
138	14.7	15.2
139	14.3	14.8
140	14.0	14.4

Wall Angle (deg.)	Bevel Angle (deg.)	Miter Angle (deg.)
141	13.7	14.1
142	13.3	13.7
143	13.0	13.3
144	12.6	12.9
145	12.3	12.6
146	11.9	12.2
147	11.6	11.8
148	11.2	11.5
149	10.9	11.1
∠ 150	10.5	10.7
151	10.2	10.4
152	9.8	10.0
153	9.5	9.6
154	9.2	9.3
155	8.8	8.9
156	8.5	8.5
157	8.1	8.2
158	7.8	7.8
159	7.4	7.5
160	7.1	7.1
161	6.7	6.7
162	6.4	6.4
163	6.0	6.0
164	5.6	5.7
165	5.3	5.3
166	4.9	5.0
167	4.6	4.6
168	4.2	4.3
169	3.9	3.9
170	3.5	3.5
171	3.2	3.2
172	2.8	2.8
173	2.5	2.5
174	2.1	2.1
175	1.8	1.8
176	1.4	1.4
177	1.1	1.1
178	0.7	7.0
179	0.4	0.4
∠ 180	0.0	0.0

001846

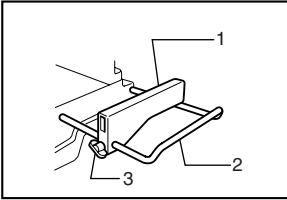

1. Set plate
2. Holder
3. Screw

## 7. Cutting repetitive lengths

When cutting several pieces of stock to the same length, ranging from 220 mm (8-5/8") to 385 mm (15-1/8"), use of the set plate (optional accessory) will facilitate more efficient operation. Install the set plate on the holder (optional accessory) as shown in the figure.

Align the cutting line on your workpiece with either the left or right side of the groove in the kerf board, and while holding the workpiece from moving, move the set plate flush against the end of the workpiece. Then secure the set plate with the screw. When the set plate is not used, loosen the screw and turn the set plate out of the way.

### NOTE:

- Use of the holder-rod assembly (optional accessory) allows cutting repetitive lengths up to 2,200 mm (7.2 ft.) approximately.

001563

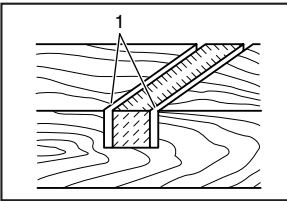

1. Cut grooves with blade

## 8. Groove cutting

A dado type cut can be made by proceeding as follows: Adjust the lower limit position of the blade using the adjusting screw and the stopper arm to limit the cutting depth of the blade. Refer to "Stopper arm" section described on previously.

After adjusting the lower limit position of the blade, cut parallel grooves across the width of the workpiece using a slide (push) cut as shown in the figure. Then remove the workpiece material between the grooves with a chisel. Do not attempt to perform this type of cut using wide (thick) blades or with a dado blade. Possible loss of control and injury may result.

### ⚠ CAUTION:

- Be sure to return the stopper arm to the original position when performing other than groove cutting.

002193

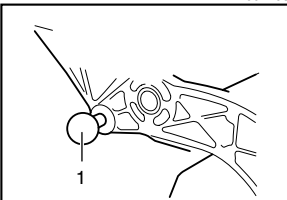

1. Stopper Pin

## Carrying tool

Make sure that the battery cartridge is removed. Secure the blade at 0° bevel angle and the turn base at right miter angle fully. Secure the slide poles after pulling the carriage toward you fully. Lower the handle fully and lock it in the lowered position by pushing in the stopper pin.

002221

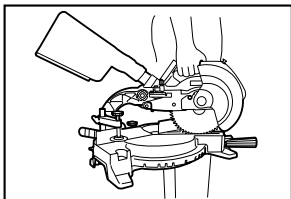

Carry the tool by carrying grip as shown in the figure. If you remove the holders, dust bag, etc., you can carry the tool more easily.

**⚠ CAUTION:**

- Always secure all moving portions before carrying the tool.
- Stopper pin is for carrying and storage purposes only and not for any cutting operations.

## MAINTENANCE

**⚠ CAUTION:**

- Always be sure that the tool is switched off and the battery cartridge is removed before attempting to perform inspection or maintenance.

**⚠ WARNING:**

- Always be sure that the blade is sharp and clean for the best and safest performance.

### Adjusting the cutting angle

This tool is carefully adjusted and aligned at the factory, but rough handling may have affected the alignment. If your tool is not aligned properly, perform the following:

#### 1. Miter angle

Push the carriage toward the guide fence and tighten the clamp screw on the turn base to secure the carriage. Loosen the grip which secures the turn base. Turn the turn base so that the pointer points to 0° on the miter scale. Then turn the turn base slightly clockwise and counterclockwise to seat the turn base in the 0° miter notch. (Leave as it is if the pointer does not point to 0°.) Loosen the hex bolts securing the guide fence using the socket wrench.

002242

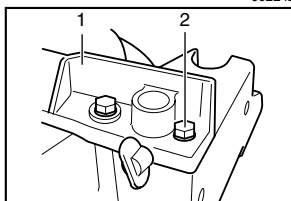

1. Guide fence
2. Hex bolt

002209

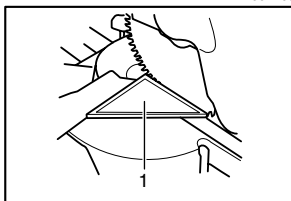

1. Triangular rule

002210

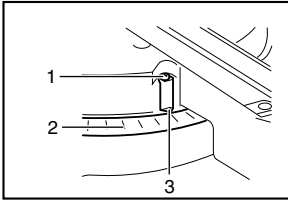

1. Screw
2. Miter scale
3. Pointer

Make sure that the pointer points to 0° on the miter scale. If the pointer does not point to 0°, loosen the screw which secures the pointer and adjust the pointer so that it will point to 0°.

002858

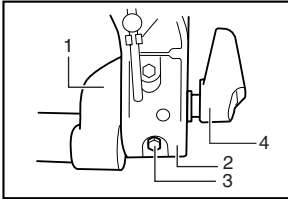

1. Arm holder
2. Arm
3. 0° bevel angle adjusting bolt
4. Lever

## 2. Bevel angle

### (1) 0° bevel angle

Push the carriage screw toward the guide fence and tighten the clamp screw on the turn base to secure the carriage. Lower the handle fully and lock it in the lowered position by pushing in the stopper pin. Loosen the lever at the rear of the tool.

Turn the 0° bevel angle adjusting bolt (lower bolt) on the right side of the arm two or three revolutions counterclockwise to tilt the blade to the right.

001819

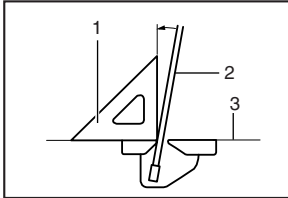

1. Triangular rule
2. Saw blade
3. Top surface of turn base

Carefully square the side of the blade with the top surface of the turn base using the triangular rule, try-square, etc. by turning the 0° bevel angle adjusting bolt clockwise. Then tighten the lever securely.

002211

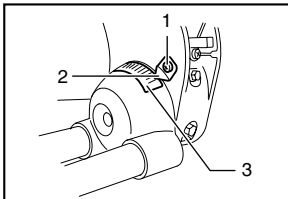

1. Screw
2. Pointer
3. Bevel scale

Make sure that the pointer on the arm points to 0° on the bevel scale on the arm holder. If it does not point to 0°, loosen the screw which secures the pointer and adjust the pointer so that it will point to 0°.

002250

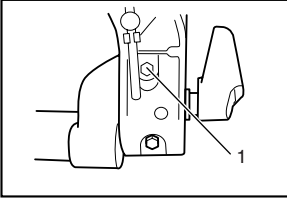

1. 45° bevel angle adjusting bolt

**(2) 45° bevel angle**

Adjust the 45° bevel angle only after performing 0° bevel angle adjustment. To adjust left 45° bevel angle, loosen the lever and tilt the blade to the left fully. Make sure that the pointer on the arm points to 45° on the bevel scale on the arm holder. If the pointer does not point to 45°, turn the 45° bevel angle adjusting bolt (upper bolt) on the right side of the arm until the pointer points to 45°.

001145

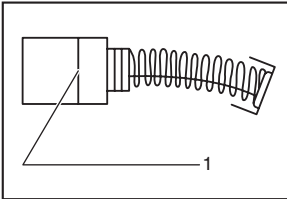

1. Limit mark

**Replacing carbon brushes**

Remove and check the carbon brushes regularly. Replace when they wear down to the limit mark. Keep the carbon brushes clean and free to slip in the holders. Both carbon brushes should be replaced at the same time. Use only identical carbon brushes.

002222

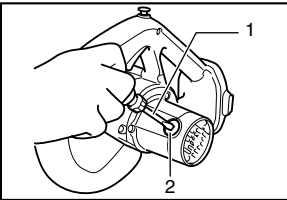

1. Screwdriver  
2. Brush holder cap

Use a screwdriver to remove the brush holder caps. Take out the worn carbon brushes, insert the new ones and secure the brush holder caps.

After replacing brushes, insert the battery cartridge into the tool and break in brushes by running tool with no load for about 1 minute. Then check the tool while running and electric brake operation when releasing the switch trigger. If electric brake is not working well, ask your local Makita service center for repair.

**After use**

- After use, wipe off chips and dust adhering to the tool with a cloth or the like. Keep the blade guard clean according to the directions in the previously covered section titled "Blade guard". Lubricate the sliding portions with machine oil to prevent rust.
- When storing the tool, pull the carriage toward you fully so that the slide pole is thoroughly inserted into the turn base.

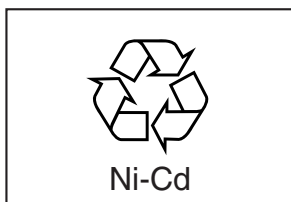

## Recycling the Battery

The only way to dispose of a Makita battery is to recycle it. The law prohibits any other method of disposal.

To recycle the battery:

1. Remove the battery from the tool.
2. a) Take the battery to your nearest Makita Factory Service Center  
or  
b) Take the battery to your nearest Makita Authorized Service Center or Distributor that has been designated as a Makita battery recycling location.

*Call your nearest Makita Service Center or Distributor to determine the location that provides Makita battery recycling. See your local Yellow Pages under "Tools-Electric".*

To maintain product SAFETY and RELIABILITY, repairs, any other maintenance or adjustment should be performed by Makita Authorized or Factory Service Centers, always using Makita replacement parts.

---

## ACCESSORIES

- These accessories or attachments are recommended for use with your Makita tool specified in this manual. The use of any other accessories or attachments might present a risk of injury to persons. Only use accessory or attachment for its stated purpose.

If you need any assistance for more details regarding these accessories, ask your local Makita service center.

- Carbide-tipped saw blades

Miter saw blades	For smooth and precise cutting in various materials.
------------------	--

- Vise assembly (Horizontal vise)
- Vertical vise
- Socket wrench 10
- Holder set
- Holder assembly
- Holder rod assembly
- Set plate
- Dust bag
- Triangular rule
- Lock-off button (2 pcs.)
- Various type of Makita genuine batteries and chargers.



**Memo**

---

---

---

---

---

---

---

---

---

---

---

---

---

---

---

---

---

---

---

---

---

---

---

---

---

---

---

---

---



Cut



**Makita Canada Inc.  
1950 Forbes Street,  
Whitby, Ontario  
L1N 7B7**

Stamp  
Timbre

Fold

# Your answers to the following questions are appreciated.

## 1. This product was purchased from?

- Hardware/lumber Store     Industrial Supply  
 Tool Distributor         Other (            )

## 3. How did you first learn of Makita Power Tools?

- Magazine/Newspaper     Catalog  
 From dealer               Other (            )  
 Store display

## 2. Use of the product is intended for?

- Construction trade     Home maintenance  
 Industrial maintenance     Other (            )

## 4. Most favored points are?

- Design                       Makita Brand  
 Features                   Power  
 Size                          Other (            )  
 Price

## 5. Any comments?

---



---



---



---



---

## Certificate of Warranty Mail to Makita

Date Purchased Month: <input style="width: 30px; height: 20px;" type="text"/> <input style="width: 30px; height: 20px;" type="text"/> Day: <input style="width: 30px; height: 20px;" type="text"/> <input style="width: 30px; height: 20px;" type="text"/> Year 20: <input style="width: 30px; height: 20px;" type="text"/> <input style="width: 30px; height: 20px;" type="text"/>	Model No. <input style="width: 100%; height: 20px;" type="text"/> <hr/> Serial No. <input style="width: 100%; height: 20px;" type="text"/>
Initial Last Name: <input style="width: 100%; height: 20px;" type="text"/>	
Male <input type="checkbox"/> Female <input type="checkbox"/> Single <input type="checkbox"/> Married <input type="checkbox"/>	
Street Address: <input style="width: 100%; height: 20px;" type="text"/>	
City: <input style="width: 300px; height: 20px;" type="text"/>	Province: <input style="width: 100%; height: 20px;" type="text"/>
Postal Code: <input style="width: 100%; height: 20px;" type="text"/>	
AGE: <input type="checkbox"/> Under 19 <input type="checkbox"/> 20-29 <input type="checkbox"/> 30-39 <input type="checkbox"/> 40-49 <input type="checkbox"/> Over 50	

Occupation:

Dealer's Name & Address:

---

# Factory Service Centres

<b>Head Office:</b>	1950 Forbes St., Whitby, Ontario, L1N 7B7 (905) 571 - 2200	1-800-263-3734
<b>Regional Office:</b>	11771 Hammersmith Way, Richmond B.C. V7A 5H6 (604) 272 - 3104	1-800-663-0909
<b>Regional Office:</b> (Montreal)	6389 boul. Couture, St. Leonard, Quebec H1P 3J5 (514) 323 - 1223	1-800-361-7049
<b>Dartmouth:</b>	202 Brownlow Avenue Dartmouth, N.S., B3B 1T5 (902) 468 - 7064	1-888-625-4821
<b>Ville St. Laurent:</b> (Montreal)	1140 Rue Bégin, Ville St. Laurent, Quebec H4R 1X1 (514) 745 - 5025	1-888-745-5025
<b>Les Saules:</b> (Quebec)	1200 St. Jean Baptiste, Unit 106, Les Saules, Quebec, G2E 5E8 (418) 871 - 5720	1-800-663-5757
<b>Nepean:</b> (Ottawa)	210 Colonnade Road, Unit 11, Nepean, Ontario, K2E 7M1 (613) 224 - 5022	1-888-560-2214
<b>Whitby:</b>	1950 Forbes St., Whitby, Ontario, L1N 7B7 (905) 571 - 2200	1-800-263-3734
<b>London:</b>	317 Adelaide St. S., Unit 117, London, Ontario, N5Z 3L3 (519) 686 - 3115	1-800-571-0899
<b>Mississauga:</b>	6350 Tomken Rd., Unit 8, Mississauga, Ontario, L5T 1Y3 (905) 670 - 7255	1-888-221-9811
<b>Calgary:</b>	#8-6115 Fourth St. S.E., Calgary Alberta, T2H 2H9 (403) 243 - 3995	1-800-267-0445
<b>Edmonton:</b>	11614-149 Street, Edmonton, Alberta, T5M 3R3 (780) 455 - 6644	1-888-455-6644
<b>Richmond:</b>	11771 Hammersmith Way, Richmond, B.C., V7A 5H6 (604) 272 - 3104	1-800-663-0909
<b>Coquitlam:</b>	2131 Hartley Ave., #103 Coquitlam, B.C. V3K 2Z3 (604) 525 - 7434	1-800-266-7738
<b>Winnipeg:</b>	1670 St. James Street, Winnipeg, Manitoba, R3H 0L3 (204) 694 - 0402	1-800-550-5073
<b>Saskatoon:</b>	206A-2750 Faithful Avenue Saskatoon, Saskatchewan, S7K 6M6 (306) 931 - 0111	1-888-931-0111

For the authorized service centre nearest you please refer to the local yellow pages directory under "tools" or contact our customer service department (Tel) 1-800-263-3734

## When you need service...

- Explain the problem in a letter
- Enclose the letter with the tool
- Package carefully and send prepaid to the nearest Makita factory or authorized service centre

## CUSTOMER RECORD

DATE  
 PURCHASED: \_\_\_\_\_  
 DEALER'S NAME  
 & ADDRESS: \_\_\_\_\_  
 \_\_\_\_\_  
 MODEL NO.: \_\_\_\_\_  
 SERIAL NO.: \_\_\_\_\_

# MAKITA LIMITED ONE YEAR WARRANTY

## Warranty Policy

Every Makita tool is thoroughly inspected and tested before leaving the factory. It is warranted to be free of defects from workmanship and materials for the period of ONE YEAR from the date of original purchase. Should any trouble develop during this one year period, return the COMPLETE tool, freight prepaid, to one of Makita's Factory or Authorized Service Centres. If inspection shows the trouble is caused by defective workmanship or material, Makita will repair (or at our option, replace) without charge.

This Warranty does not apply:

- where normal maintenance is required,
- repairs have been made or attempted by others,
- the tool has been abused, misused or improperly maintained,
- alterations have been made to the tool.

IN NO EVENT SHALL MAKITA BE LIABLE FOR ANY INDIRECT, INCIDENTAL OR CONSEQUENTIAL DAMAGES FROM THE SALE OR USE OF THE PRODUCT. THIS DISCLAIMER APPLIES BOTH DURING AND AFTER THE TERM OF THIS WARRANTY.

"The Makita Warranty is the only and the entire written warranty given by Makita for the Makita tools. No dealer or his agent or employee is authorized to extend or enlarge upon this warranty by any verbal or written statement or advertisement."

MAKITA DISCLAIMS LIABILITY FOR ANY IMPLIED WARRANTIES INCLUDING IMPLIED WARRANTIES OF "MERCHANTABILITY" AND FITNESS FOR A SPECIFIC PURPOSE," AFTER THE ONE YEAR TERM OF THIS WARRANTY.

"This Warranty gives you specific rights. The provisions contained in this warranty are not intended to limit, modify, take away from, disclaim or exclude any warranties set forth in any provincial legislation. To the extent required by law, the provisions in any provincial or federal legislation with respect to warranties take precedence over the provisions in this warranty."

**Makita Corporation of America**

2650 Buford Hwy., Buford, GA 30518